

Description

The μPD27C1000A is a 1,048,576-bit ultraviolet erasable and electrically programmable read-only memory fabricated with double-polysilicon CMOS technology for a substantial savings in both operating and standby power. The device is organized as 131,072 words by 8 bits and operates from a single +5-volt power supply.

The μPD27C1000A has both page and single-location programming features, three-state outputs, and fully TTL-compatible inputs and outputs. It also has a program voltage (V_{PP}) of 12.5 volts and is available in a 32-pin cerdip with quartz window.

Features

- 131,072-word x 8-bit organization
- Ultraviolet erasable and electrically programmable
- High-speed programming capability
 - Page programming
 - Byte programming
- Low power dissipation
 - 40 mA maximum (active)
 - 100 μA maximum (standby)
- TTL-compatible I/O for reading and programming
- Single +5-volt power supply
- Double-polysilicon CMOS technology
- 32-pin cerdip packaging
- Pinout compatibility with 28-pin mask-programmable μPD23C1000s

Ordering Information

Part Number	Access Time (max)	Package
μPD27C1000AD-12	120 ns	32-pin cerdip with a quartz window
D-15	150 ns	
D-20	200 ns	

Pin Configuration

32-Pin Cerdip

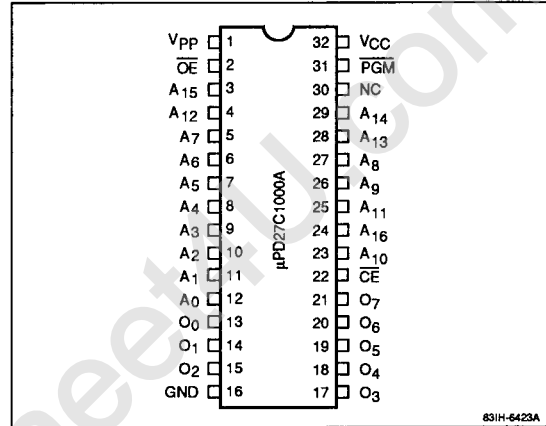

Pin Identification

Symbol	Function
A ₀ - A ₁₆	Address inputs
O ₀ - O ₇	Data outputs
CE	Chip enable
OE	Output enable
PGM	Program
GND	Ground
V _{CC}	+5-volt power supply
V _{PP}	Program voltage
NC	No connection

Absolute Maximum Ratings

Power supply voltage, V_{CC}	-0.6 to +7.0 V
Input voltage, V_{IN}	-0.6 to +7.0 V
Input voltage, A_9	-0.6 to +13.5 V
Output voltage, V_{OUT}	-0.6 to +7.0 V
Operating temperature, T_{OPR}	-10 to +80°C
Storage temperature, T_{STG}	-65 to +125°C
Program voltage, V_{PP}	-0.6 to +13.5 V

Exposure to Absolute Maximum Ratings for extended periods may affect device reliability; exceeding the ratings could cause permanent damage. The device should be operated within the limits specified under DC and AC Characteristics.

Capacitance

$T_A = 25^\circ\text{C}; f = 1 \text{ MHz}; V_{IN} \text{ and } V_{OUT} = 0 \text{ V}$

Parameter	Symbol	Min	Typ	Max	Unit
Input capacitance	C_{IN}			14	pF
Output capacitance	C_{OUT}			16	pF

Truth Table

Function	\overline{CE}	\overline{OE}	\overline{PGM}	V_{PP}	V_{CC}	Output
Read	V_{IL}	V_{IL}	V_{IH}	+5.0 V	+5.0 V	D _{OUT}
Output disable	V_{IL}	V_{IH}	X	+5.0 V	+5.0 V	High-Z
Standby	V_{IH}	X	X	+5.0 V	+5.0 V	High-Z
Page data latch	V_{IH}	V_{IL}	V_{IH}	+12.5 V	+6.5 V	D _{IN}
Page program	V_{IH}	V_{IH}	V_{IL}	+12.5 V	+6.5 V	High-Z
Byte program	V_{IL}	V_{IH}	V_{IL}	+12.5 V	+6.5 V	D _{IN}
Program verify	V_{IL}	V_{IL}	V_{IH}	+12.5 V	+6.5 V	D _{OUT}
Program inhibit	X	V_{IL}	V_{IL}	+12.5 V	+6.5 V	High-Z
	X	V_{IH}	V_{IH}			

Notes:

- (1) X can be either V_{IL} or V_{IH} .
- (2) In read operation, \overline{PGM} must be set to V_{IH} at all times, or switched from V_{IL} to V_{IH} at least 2 μs before \overline{OE} or \overline{CE} goes to V_{IH} .

Block Diagram

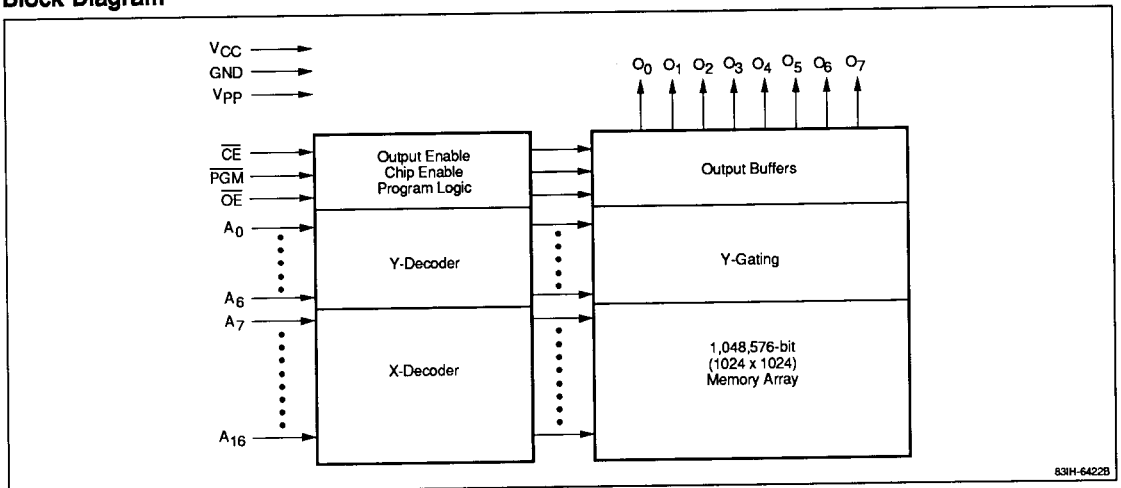

Recommended Operating Conditions

Parameter	Symbol	Min	Typ	Max	Unit
Read Operation or Standby					
Supply voltage	V_{CC}	4.5	5.0	5.5	V
	V_{PP}	$V_{CC} - 0.6$	V_{CC}	$V_{CC} + 0.6$	V
Input voltage, high	V_{IH}	2.0		$V_{CC} + 0.3$	V
Input voltage, low	V_{IL}	-0.3		0.8	V
Operating temperature	T_A	0		70	°C
Programming Operation					
Supply voltage	V_{CC}	6.25	6.5	6.75	V
	V_{PP}	12.2	12.5	12.8	V
Input voltage, high	V_{IH}	2.4		$V_{CC} + 0.3$	V
Input voltage, low	V_{IL}	-0.3		0.8	V
Operating temperature	T_A	20	25	30	°C

DC Characteristics

$T_A = 0$ to $+70^\circ\text{C}$; $V_{CC} = +5.0\text{V} \pm 10\%$; $V_{PP} = V_{CC} \pm 0.6$

Parameter	Symbol	Min	Typ	Max	Unit	Test Conditions
Read Operation or Standby						
Output voltage, high	V_{OH1}	2.4			V	$I_{OH} = -400\ \mu\text{A}$
	V_{OH2}	$V_{CC} - 0.7$			V	$I_{OH} = -100\ \mu\text{A}$
Output voltage, low	V_{OL}			0.45	V	$I_{OL} = 2.1\ \text{mA}$
Output leakage current	I_{LO}	-10		10	μA	$V_{OUT} = 0\ \text{V to } V_{CC}$; $\overline{OE} = V_{IH}$
Input leakage current	I_{LI}	-10		10	μA	$V_{IN} = 0\ \text{V to } V_{CC}$
V_{PP} current	I_{PP}		1	100	μA	$V_{PP} = V_{CC}$
V_{CC} current (active)	I_{CCA1}			15	mA	$\overline{CE} = V_{IL}$; $V_{IN} = V_{IH}$
	I_{CCA2}			40	mA	$f = 8.4\ \text{MHz}$; $I_{OUT} = 0\ \text{mA}$; $t_{ACC} = 120\ \text{ns}$
				30	mA	$f = 6.7\ \text{MHz}$; $I_{OUT} = 0\ \text{mA}$; $t_{ACC} = 150\ \text{ns}$
			25	mA	$f = 5\ \text{MHz}$; $I_{OUT} = 0\ \text{mA}$; $t_{ACC} = 200\ \text{ns}$	
V_{CC} current (standby)	I_{CCS1}			1	mA	$\overline{CE} = V_{IH}$
	I_{CCS2}		1	100	μA	$\overline{CE} = V_{CC}$; $V_{IN} = 0\ \text{V to } V_{CC}$

DC Characteristics (cont)

$T_A = 25 \pm 5^\circ\text{C}$; $V_{CC} = +6.5\text{V} \pm 0.25$; $V_{PP} = +12.5\text{V} \pm 0.3$

Parameter	Symbol	Min	Typ	Max	Unit	Test Conditions
Programming Operation						
Output voltage, high	V_{OH}	2.4			V	$I_{OH} = -400\ \mu\text{A}$
Output voltage, low	V_{OL}			0.45	V	$I_{OL} = 2.1\ \text{mA}$
Input leakage current	I_{LI}	-10		10	μA	$V_{IN} = V_{IL}$ or V_{IH}
V_{PP} current	I_{PP}			50	mA	$\overline{CE} = \text{PGM} = V_{IL}$
V_{CC} current	I_{CC}			30	mA	

AC Characteristics

$T_A = 0 \text{ to } +70^\circ\text{C}; V_{CC} = +5.0 \text{ V} \pm 10\%; V_{PP} = V_{CC} \pm 0.6 \text{ V}$

Parameter	Symbol	μPD27C1000A-12		μPD27C1000A-15		μPD27C1000A-20		Unit	Test Conditions
		Min	Max	Min	Max	Min	Max		
Read Operation or Standby									
Address to output delay	t_{ACC}		120		150		200	ns	$\overline{CE} = \overline{OE} = V_{IL}$
\overline{CE} to output delay	t_{CE}		120		150		200	ns	$\overline{OE} = V_{IL}$
\overline{OE} to output delay	t_{OE}		70		70		75	ns	$\overline{CE} = V_{IL}$
\overline{OE} or \overline{CE} high to output float	t_{DF}	0	50	0	50	0	60	ns	$\overline{CE} = V_{IL}$ or $\overline{OE} = V_{IL}$
Address to output hold	t_{OH}	0		0		0		ns	$\overline{CE} = \overline{OE} = V_{IL}$

AC Characteristics (cont)

$T_A = +25 \pm 5^\circ\text{C}; V_{CC} = +6.5 \pm 0.25 \text{ V}; V_{PP} = +12.5 \pm 0.3 \text{ V}$

Parameter	Symbol	Min	Typ	Max	Unit	Test Conditions
Page Programming Operation						
Address setup time	t_{AS}	2			μs	
\overline{CE} setup time	t_{CES}	2			μs	
Data setup time	t_{DS}	2			μs	
Address hold time	t_{AH}	2			μs	
	t_{AHL}	2			μs	
	t_{AHV}	0			μs	
Data hold time	t_{DH}	2			μs	
\overline{OE} to output float time	t_{DF}	0		130	ns	
V_{PP} setup time	t_{VPS}	2			μs	
V_{CC} setup time	t_{VCS}	2			μs	
Program pulse width	t_{PW}	0.095	0.1	0.105	ms	
\overline{OE} setup time	t_{OES}	2			μs	
\overline{OE} to output delay	t_{OE}			150	ns	
\overline{OE} pulse width during data latch	t_{LW}	1			μs	
PGM setup time	t_{PGMS}	2			μs	
\overline{CE} hold time	t_{CEH}	2			μs	
\overline{OE} hold time	t_{OEH}	2			μs	

AC Characteristics (cont)

Parameter	Symbol	Min	Typ	Max	Unit	Test Conditions
Byte Programming Operation						
Address setup time	t_{AS}	2			μs	
\overline{OE} setup time	t_{OES}	2			μs	
Data setup time	t_{DS}	2			μs	
Address hold time	t_{AH}	2			μs	
Data hold time	t_{DH}	2			μs	
\overline{OE} to output float time	t_{DF}	0		130	ns	
V_{PP} setup time	t_{VPS}	2			μs	
V_{CC} setup time	t_{VCS}	2			μs	
Program pulse width	t_{PW}	0.095	0.1	0.105	ms	
\overline{CE} setup time	t_{CES}	2			μs	
\overline{OE} to output delay	t_{OE}			150	ns	

Notes:

- (1) Input pulse levels = 0.45 to 2.4 V; Input and output timing reference levels = 0.8 and 2.0 V; Input rise and fall times \leq 20 ns. See figure 1 for output load.

Figure 1. Output Load

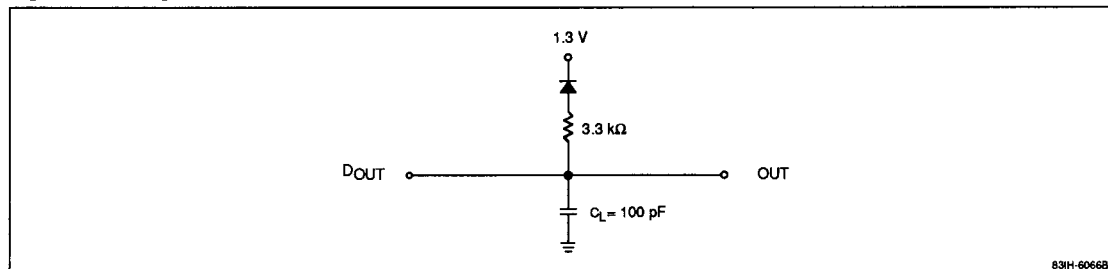

Programming Operation

Begin programming by erasing all data; this sets all data bits high. The μPD27C1000A is originally shipped in this condition. To enter data, program a low-level TTL signal into the chosen location. Address the first byte or page location and apply valid data at the eight output pins. Raise V_{CC} to $+6.5\text{ V} \pm 0.25$ and V_{PP} to $+12.5\text{ V} \pm 0.3$.

Byte Programming

For byte programming, \overline{CE} should be set low and \overline{OE} high to start programming at the initial address. Apply a 0.1-ms program pulse to \overline{PGM} , as shown in the byte programming portion of the timing waveforms. Set \overline{OE} low to verify the eight bits prior to making a program/no program decision. If the byte is not programmed, apply another 0.1-ms pulse to \overline{PGM} , up to a maximum of 10 times, and input the next address. If the bits are not programmed in 10 tries, reject the device as a program failure. After all addresses are programmed, lower both V_{CC} and V_{PP} to $+5.0\text{ V} \pm 10\%$ and verify all data again.

Page Programming

For page programming, \overline{CE} and \overline{PGM} should be set high. \overline{OE} pulses low four times to latch the addressed 4-byte, 1-page data. Subsequently, \overline{CE} and \overline{OE} should be set high and a 0.1-ms program pulse applied to \overline{PGM} , as shown in the page programming portion of the timing waveforms. Verify the data prior to making a program/no program decision. If all 4 bytes of page data are not programmed, apply another 0.1-ms pulse to \overline{PGM} , up to a maximum of 10 times and input the next page address. If the page is not programmed in 10 tries, reject the device as a program failure. After all addresses are programmed, lower both V_{CC} and V_{PP} to $+5.0\text{ V} \pm 10\%$ and verify all data again.

Program Inhibit

Use the programming inhibit option to program multiple μPD27C1000As connected in parallel. All like inputs except \overline{PGM} and \overline{OE} may be common. Program individual devices by applying a low-level TTL pulse to the \overline{PGM} pin of the devices to be programmed. Apply a high-level signal to the \overline{PGM} pins of the other devices to prevent them from being programmed.

Program Verification

To verify that the device is correctly programmed, normal read cycles can be executed with a high logic level applied to the \overline{PGM} pin and low logic levels applied to the \overline{CE} and \overline{OE} pins of the device to be verified. The \overline{CE} or \overline{OE} pins of all other devices should be set high.

Program Erasure

Erase data on the μPD27C1000A by exposing it to light with a wavelength shorter than 400 nm. Since exposure to direct sunlight or room-level fluorescent light could also erase the data, mask the window to prevent unintentional erasure by ultraviolet rays. Opaque labels are supplied with every device.

Data is typically erased by ultraviolet rays with a wavelength of 254 nm. A minimum integrated dose of 15 W-sec/cm² (ultraviolet lighting intensity multiplied by exposure time) is required to completely erase written data.

An ultraviolet lamp rated at 12,000 μW/cm² will complete erasure in approximately 15 to 20 minutes. Place the μPD27C1000A within 2.5 cm of the lamp tubes and remove any filter on the lamp.

Timing Waveforms

Read Cycle

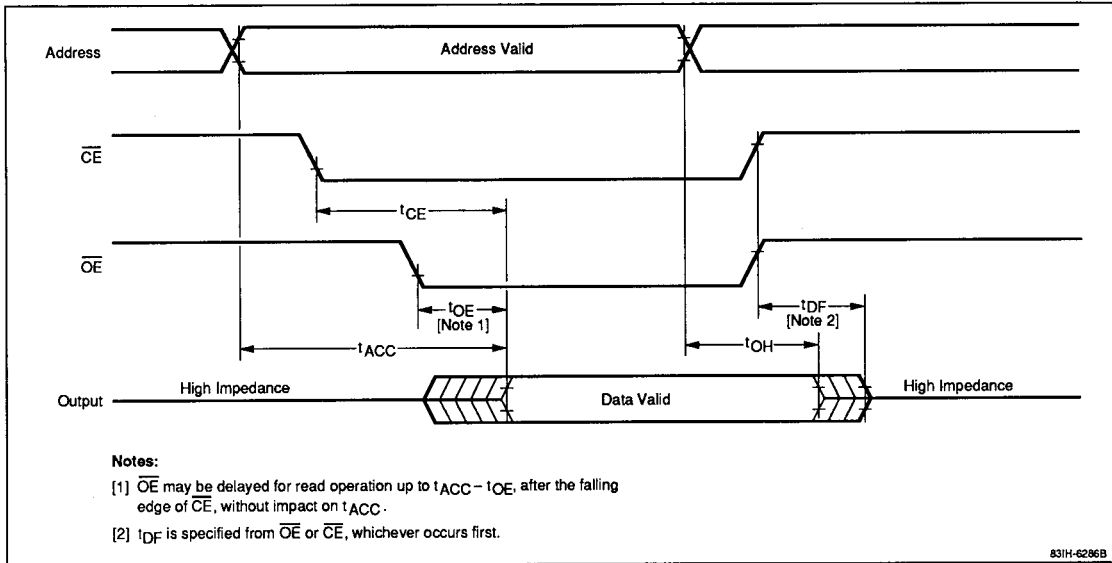

Timing Waveforms (cont)

Page Programming Cycle

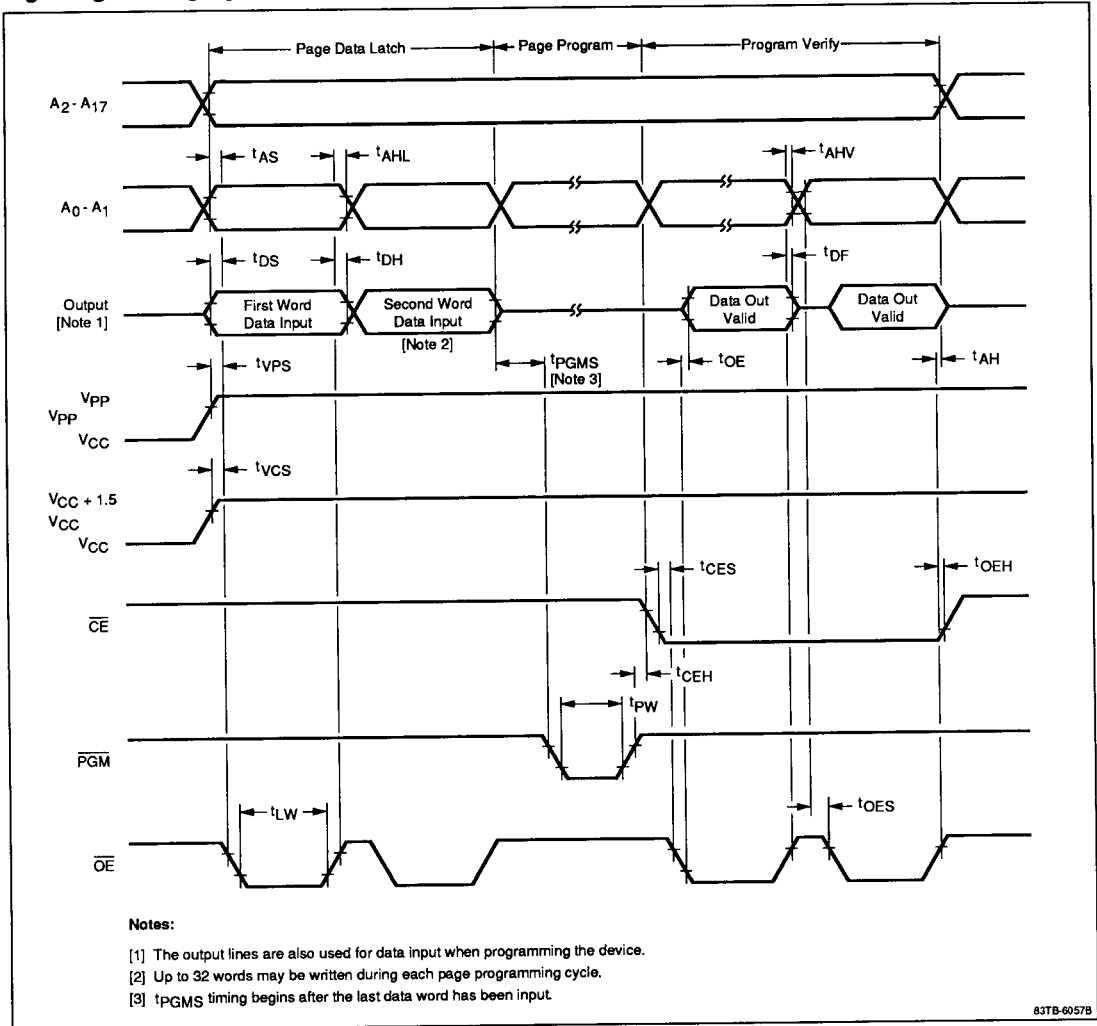

83TB-6057B

Figure 2. Page Programming Flowchart

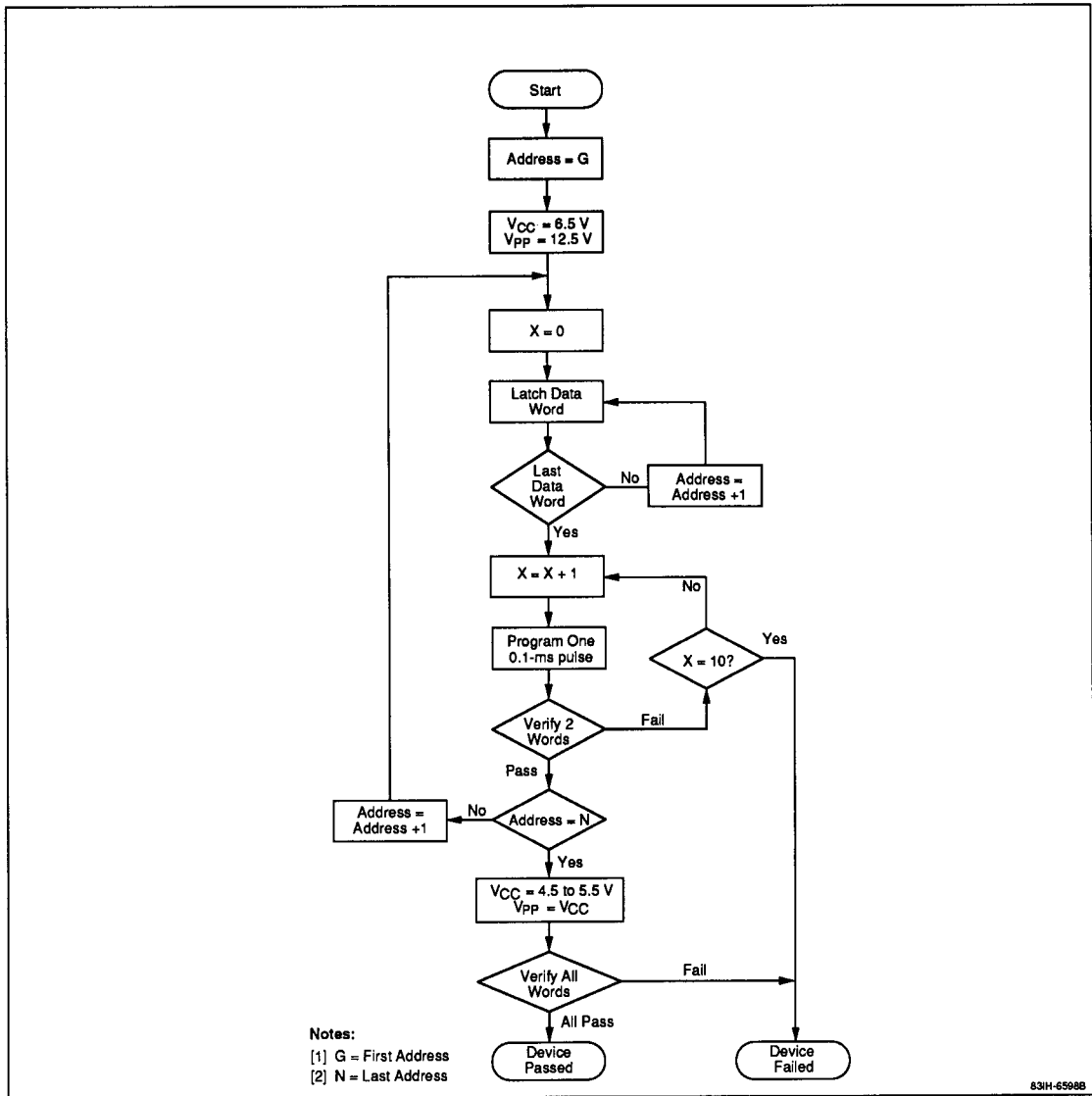

Timing Waveforms (cont)

Byte Programming

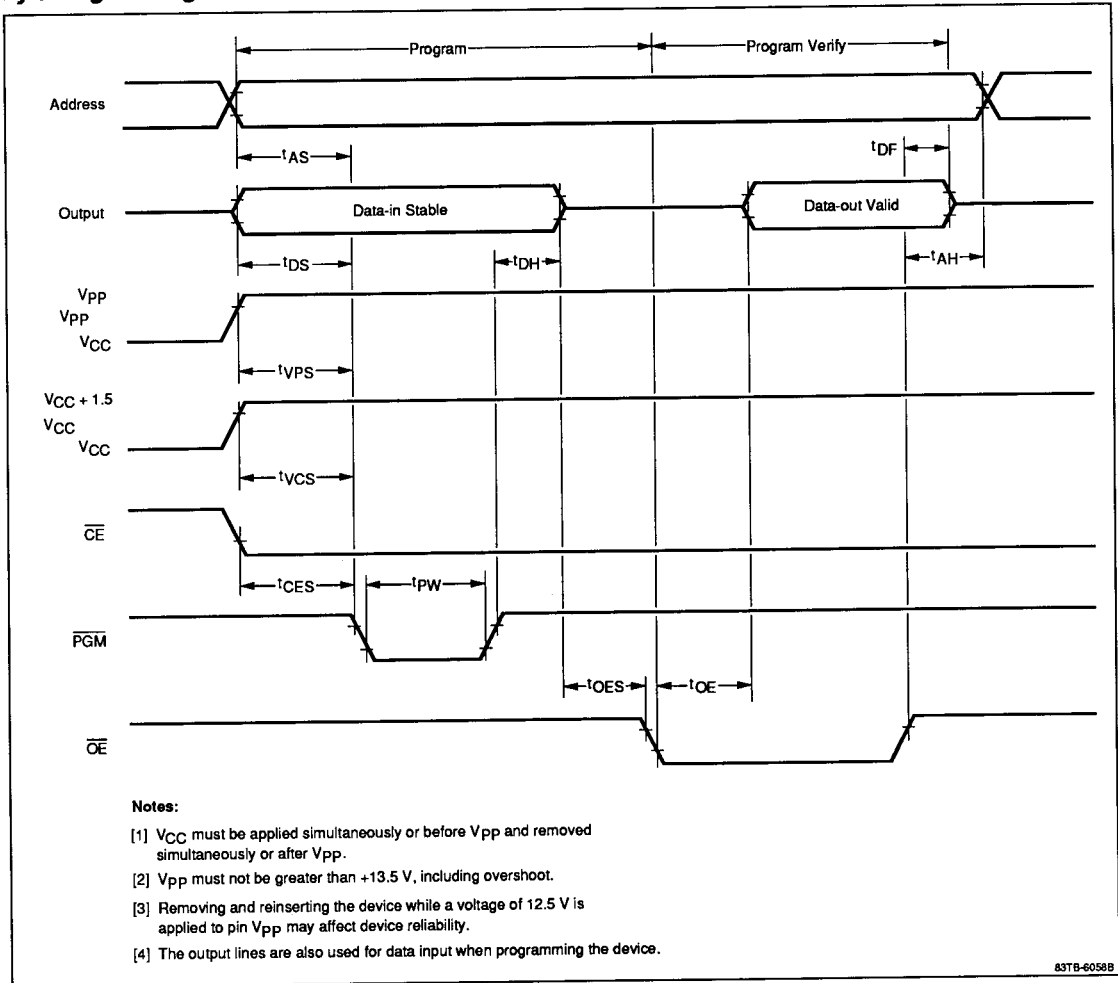

Figure 3. Byte Programming Flowchart

